

DG234-5.0

- PUSH-IN结构; 接线方便;
- 带按钮结构, 取线方便;
- 双排焊脚, 产品牢固性好;
- Push-in structure, easy to connect.
- With button structure, easy to release.
- Double pins, firm connection.

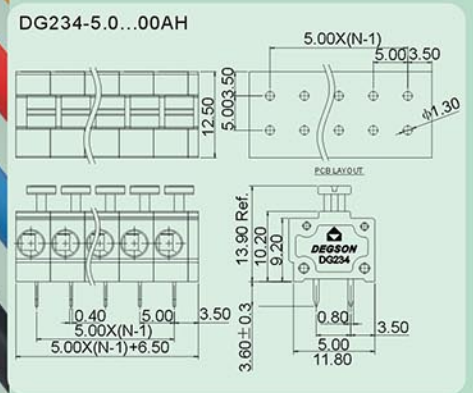
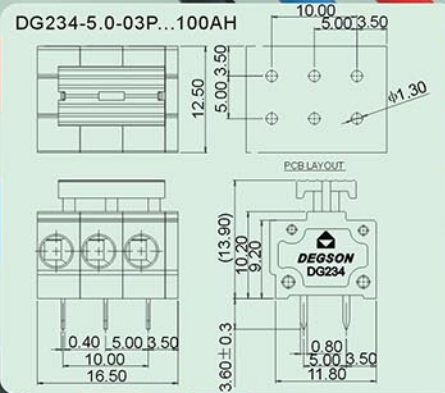

技术参数 Technical data

APPROVAL: CE

型号 Model	线径 Wire range (AWG/mm ²)	线数 Poles	IEC60947技术参数 (IEC60947 data sheet)		UL1059技术参数 (UL1059 data sheet)	
			电压(V) Rated voltage	电流(A) Rated current	电压(V) Rated voltage	电流(A) Rated current
DG234-5.0	30-16/0.5-1.5	02-24P	320	10	300	10
DG234-5.0-100A	30-16/0.5-1.5	03P	320	10	300	10

应用行业 Application

照明, 工业自动化, 仪器仪表, 安防, 照明等行业。
industrial automation, instrument, security, Lighting etc.



产品包装方式 Packing

Product model	Pcs./Pkt.	Product model	Pcs./Pkt.
DG234-5.0-02P	50	DG234-5.0-08P	50
DG234-5.0-03P	50	DG234-5.0-09P	50
DG234-5.0-04P	50	DG234-5.0-10P	50
DG234-5.0-05P	50	DG234-5.0-11P	50
DG234-5.0-06P	50	DG234-5.0-12P	50
DG234-5.0-07P	50		

型号对照 Cross reference

DEGSON	同行1/Competitor1	同行2/Competitor2
DG234-5.0	-	-
DG234-5.0-100A	-	-

产品订货 How to order

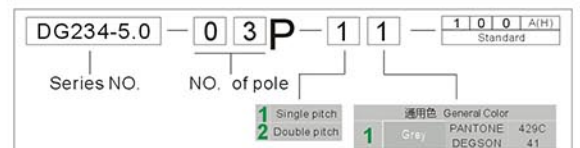
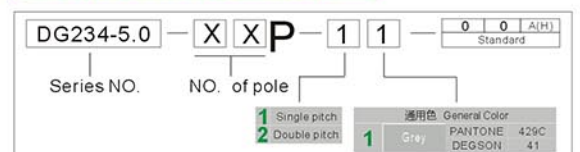

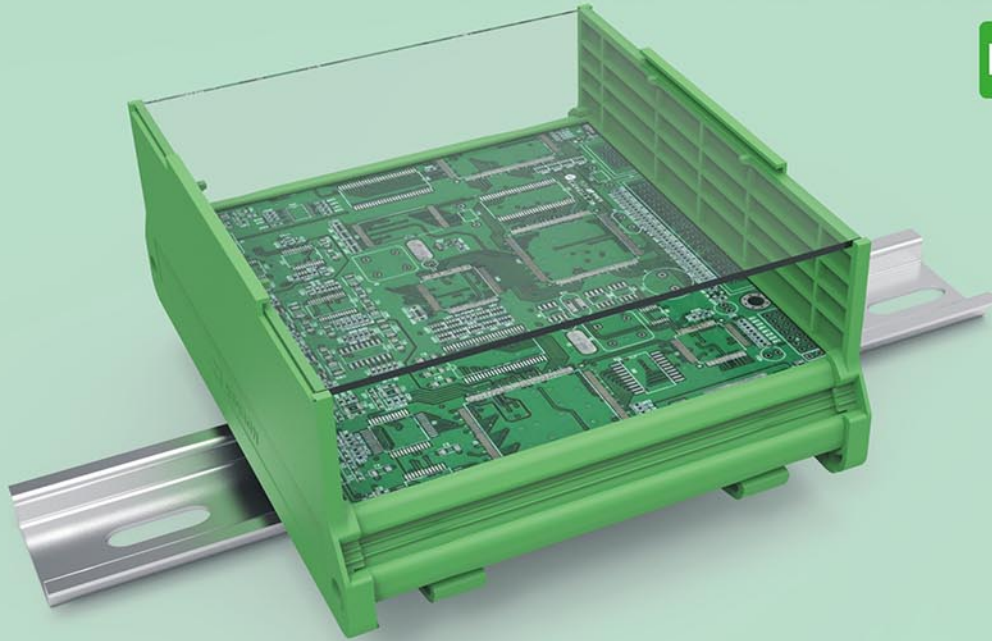

DM108-XXXX-1Y-150AH

- 在DM108-00AH基础上增加顶部透明盖板;
- Adding transparent cover at the top based on DM108-00AH.

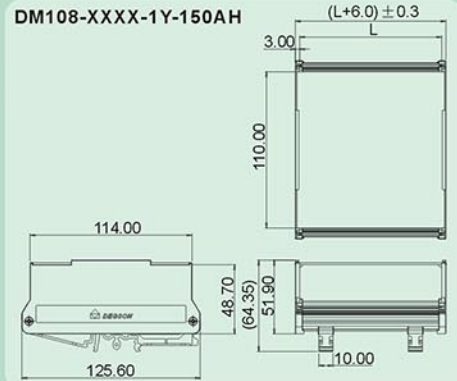

技术参数 Technical data

APPROVAL: **CE**

型号 Model	线径 Wire range (AWG/mm ²)	线数 Poles	IEC60947技术参数 (IEC60947 data sheet)		UL1059技术参数 (UL1059 data sheet)	
			电压(V) Rated voltage	电流(A) Rated current	电压(V) Rated voltage	电流(A) Rated current
DM108	-	01P	-	-	-	-

应用行业 Application

工业自动化, 仪器仪表, 电梯, 机械, 电力电气等行业。
industrial automation, instrument, elevator, machinery, electric power etc.



产品包装方式 Packing

Product model	Pcs./Pkt.
DM108	10

型号对照 Cross reference

DEGSON	同行1/Competitor1	同行2/Competitor2
DM108	-	-

产品订货 How to order

DM108	-	X X X X	-	1 4	-	1 5 10 A(H)	Standard
Series NO.		Length		1 Single pitch 2 Double pitch		通用色 General Color	
				4		Green	PANTONE 556C DEGSON 04

8EDGKRMA-5.08-20P-11-07AH

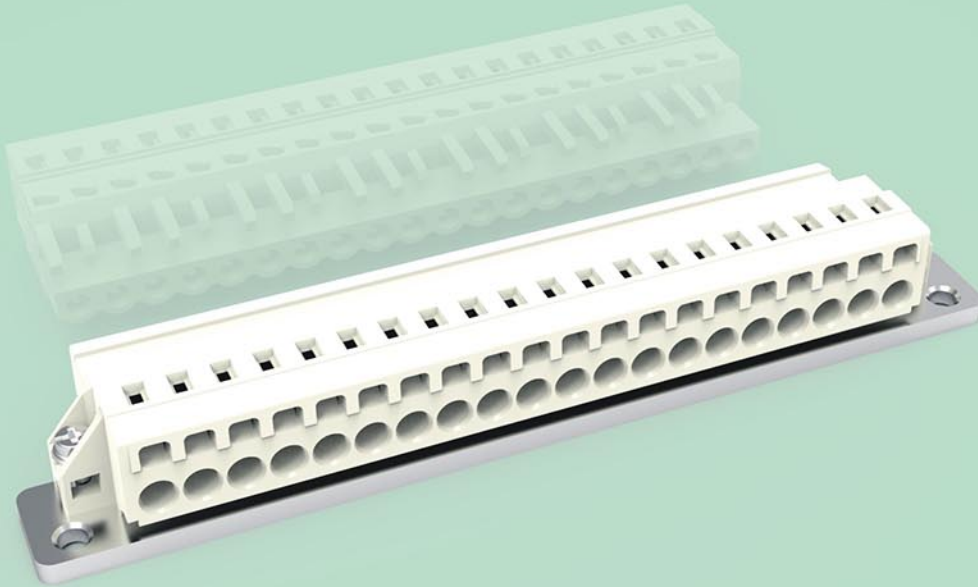

- 在8EDGKRMA-5.08-00AH基础上增加固定片;
- Adding fixed plate based on 8EDGKRMA-5.08-00AH.

8EDGKRMA-5.08-20P-11-07AH

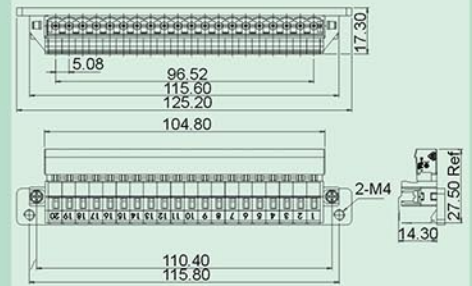

技术参数 Technical data

APPROVAL: 

型号 Model	线径 Wire range (AWG/mm ²)	线数 Poles	EN61984技术参数 (EN61984 data sheet)		UL技术参数 (UL data sheet)	
			电压(V) Rated voltage	电流(A) Rated current	电压(V) Rated voltage	电流(A) Rated current
8EDGKRMA-5.08	22-14/0.2-2.5	20P	320	20	300	15

应用行业 Application

电力电气等行业
electric power etc.



产品包装方式 Packing

Product model	Pcs./Pkt.
8EDGKRMA-5.08	10

型号对照 Cross reference

DEGSON	同行1/Competitor1	同行2/Competitor2
8EDGKRMA-5.08	-	-

产品订货 How to order

8EDGKRMA-5.08	2	0	P	1	1	0	7	A(H)
Series NO.	NO. of pole					Standard		
	1 Single pitch	2 Double pitch				通用色 General Color		
					1	Grey	PANTONE 429C	DEGSON 41

FMED-02P/FMED-03P

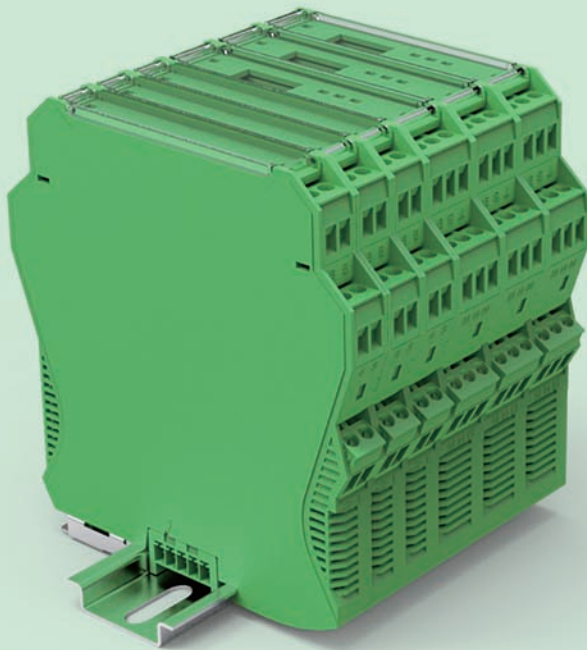

- 三进二出端子连接结构, 满足电路多样化需求;
 - 快速度卡接, 操作方便;
 - PC材质, 保障产品抗变形能力;
 - 轨道固定方式, 安装方便;
 - 同行专利问题, 禁销欧盟与美国;
- Three in two out connect structure . meet circuit various requirement.
 - Easy using with K-bus , easy operation.
 - PC housing material . sure the anti-distortion performance.
 - Din-rail fixed type , easy fixing.
 - Patent problems , ban selling to EU and USA

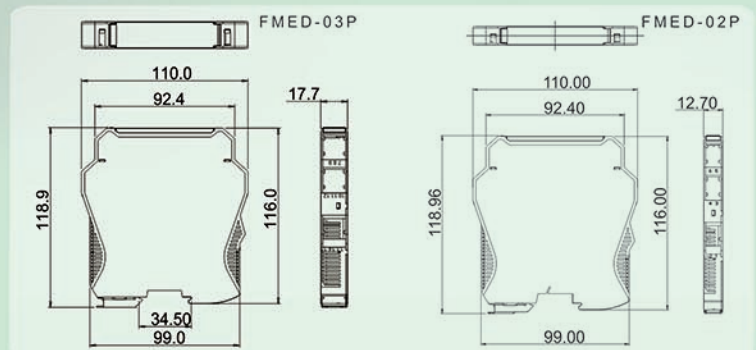

技术参数 Technical Data

APPROVAL: CE

型号 Model	线径 Wire range	线数 Poles	IEC61984技术参数(IEC61984 datasheet)				UL1059技术参数(UL1059 datasheet)			
			电压(V)	Rated voltage	电流(A)	Rated current	电压(V)	Rated voltage	电流(A)	Rated current
FMED-02P	—	02P	—	—	—	—	—	—	—	
FMED-03P	—	03P	—	—	—	—	—	—	—	

应用行业 Application

仪器仪表行业。
Instrument etc.



产品包装方式 Packing

Product model	Pcs./Pkt.
FMED-02P	10
FMED-03P	10

附件 Accessory

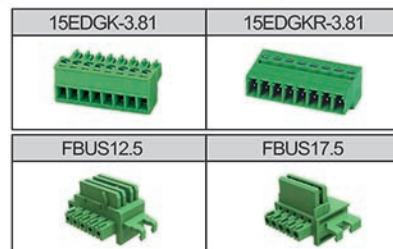

产品订货 How to order

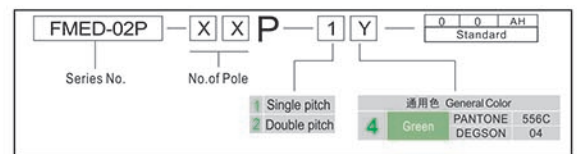

产品订货 How to order

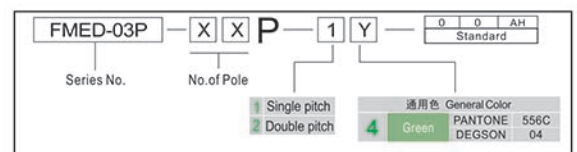

FMEH-02P

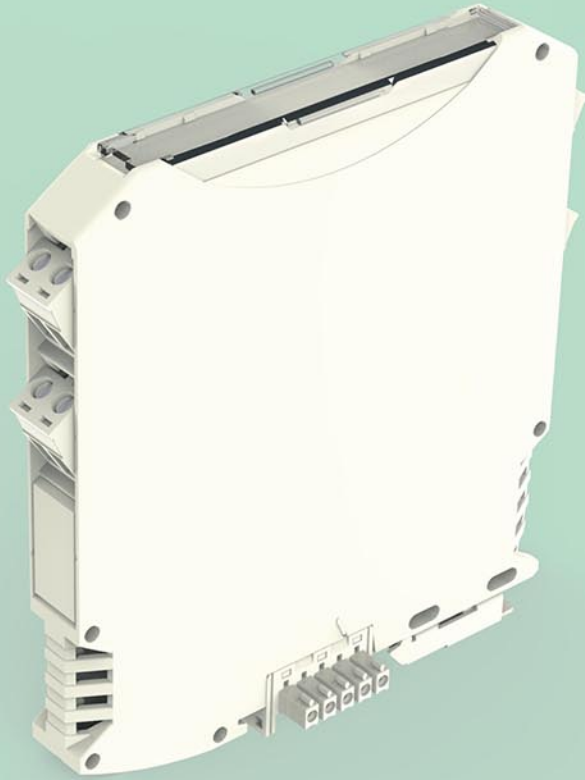

- 结构紧凑,适用于大尺寸的PCB;
- 可提供DIN导轨式总线连接器;
- 提供三层6个插拔式端子或防尘盖可供选择;
- 透明盖板可以转动并卸下;
- 功能接地连接可选;
- 提供12.6/17.6/22.6mm三种厚度。
- Compact structure, suitable for large sized PCB;
- DIN rail bus connectors available;
- Three-layer 6 pluggable terminal blocks or dust-proof cover available;
- Transparent cover can be rotated and removed;
- PE function available;
- Thickness:12.6/17.6/22.6mm available.

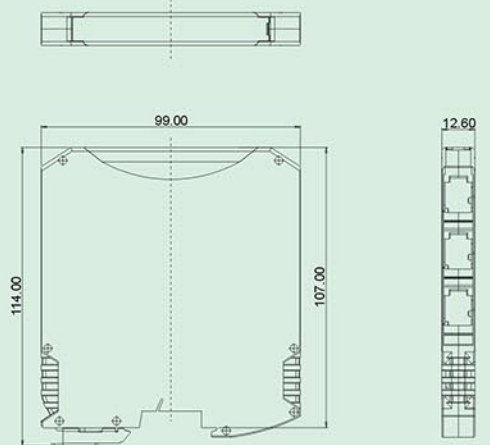

技术参数 Technical data

APPROVAL: **CE**

型号 Model	线径 Wire range (AWG/mm ²)	线数 Poles	IEC61984技术参数 (IEC61984 data sheet)		UL1059技术参数 (UL1059 data sheet)	
			电压(V) Rated voltage	电流(A) Rated current	电压(V) Rated voltage	电流(A) Rated current
FMEH-02P	-/-	-	-	-	-	-

应用行业 Application

仪器仪表等行业。
Instrument etc.



产品包装方式 Packing

Product model	Pcs./Pkt.
FMEH-02P	10

型号对照 Cross reference

DEGSON	同行1/Competitor1	同行2/Competitor2
FMEH-02P	MEMAX12.5	-

产品订货 How to order

FMEH	-	0	2	P	-	1	Y	-	0	0	A(H)
Series NO.		NO. of pole							Standard		
		1	2						通用色 Grey	General Color PANTONE 430C	41
									DEGSON		

FMEH-03P/FBUS17.5

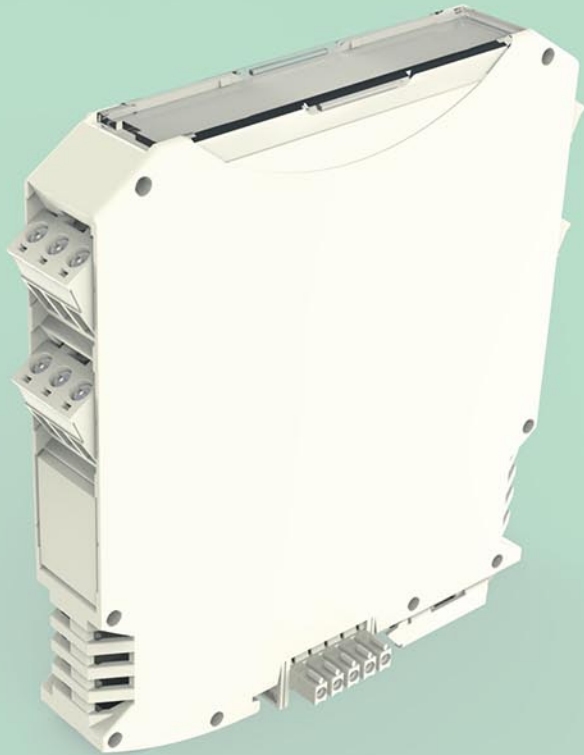

- 结构紧凑,适用于大尺寸的PCB;
- 可提供DIN导轨式总线连接器;
- 提供三层6个插拔式端子或防尘盖可供选择;
- 透明盖板可以转动并卸下;
- 功能接地连接可选;
- 提供12.6/17.6/22.6mm三种厚度。
- Compact structure, suitable for large sized PCB;
- DIN rail bus connectors available;
- Three-layer 6 pluggable terminal blocks or dust-proof cover available;
- Transparent cover can be rotated and removed;
- PE function available;
- Thickness:12.6/17.6/22.6mm available.

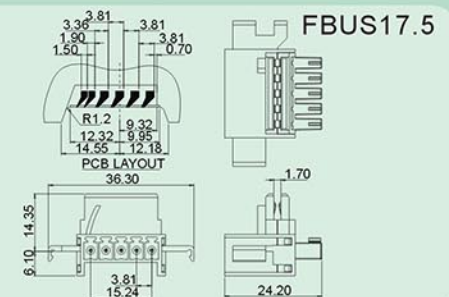
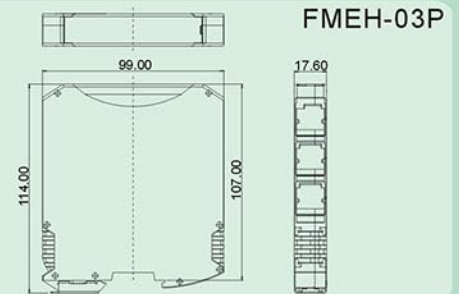

技术参数 Technical data

APPROVAL: **CE**

型号 Model	线径 Wire range (AWG/mm ²)	线数 Poles	IEC61984技术参数 (IEC61984 data sheet)		UL1059技术参数 (UL1059 data sheet)	
			电压(V) Rated voltage	电流(A) Rated current	电压(V) Rated voltage	电流(A) Rated current
FMEH-03P	-/-	-	-	-	-	-
FBUS17.5	-/-	-	-	-	-	-

应用行业 Application

仪器仪表等行业。
Instrument etc.



产品包装方式 Packing

Product model	Pcs./Pkt.
FMEH-03P	10

型号对照 Cross reference

DEGSON	同行1/Competitor1	同行2/Competitor2
FMEH-03P	MEMAX17.5	-
FBUS17.5	-	-

产品订货 How to order

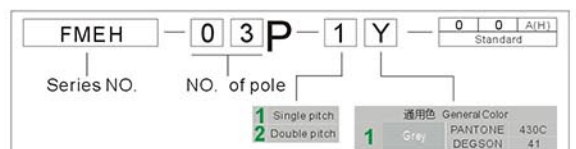

FMEH-04P/FBUS22.5



- 结构紧凑,适用于大尺寸的PCB;
- 可提供DIN导轨式总线连接器;
- 提供三层6个插拔式端子或防尘盖可供选择;
- 透明盖板可以转动并卸下;
- 功能接地连接可选;
- 提供12.6/17.6/22.6mm三种厚度。
- Compact structure, suitable for large sized PCB;
- DIN rail bus connectors available;
- Three-layer 6 pluggable terminal blocks or dust-proof cover available;
- Transparent cover can be rotated and removed;
- PE function available;
- Thickness:12.6/17.6/22.6mm available.

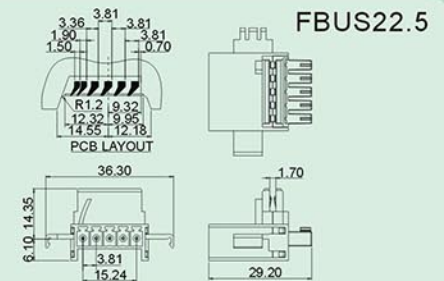
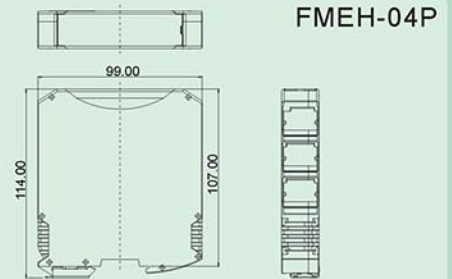

技术参数 Technical data

APPROVAL: **CE**

型号 Model	线径 Wire range (AWG/mm ²)	线数 Poles	IEC61984技术参数 (IEC61984 data sheet)		UL1059技术参数 (UL1059 data sheet)	
			电压(V) Rated voltage	电流(A) Rated current	电压(V) Rated voltage	电流(A) Rated current
FMEH-04P	-/-	-	-	-	-	-
FBUS22.5	-/-	-	-	-	-	-

应用行业 Application

仪器仪表等行业。
Instrument etc.



产品包装方式 Packing

Product model	Pcs./Pkt.
FMEH-04P	10

型号对照 Cross reference

DEGSON	同行1/Competitor1	同行2/Competitor2
FMEH-04P	MEMAX22.5	-
FBUS22.5	-	-

产品订货 How to order

